

+

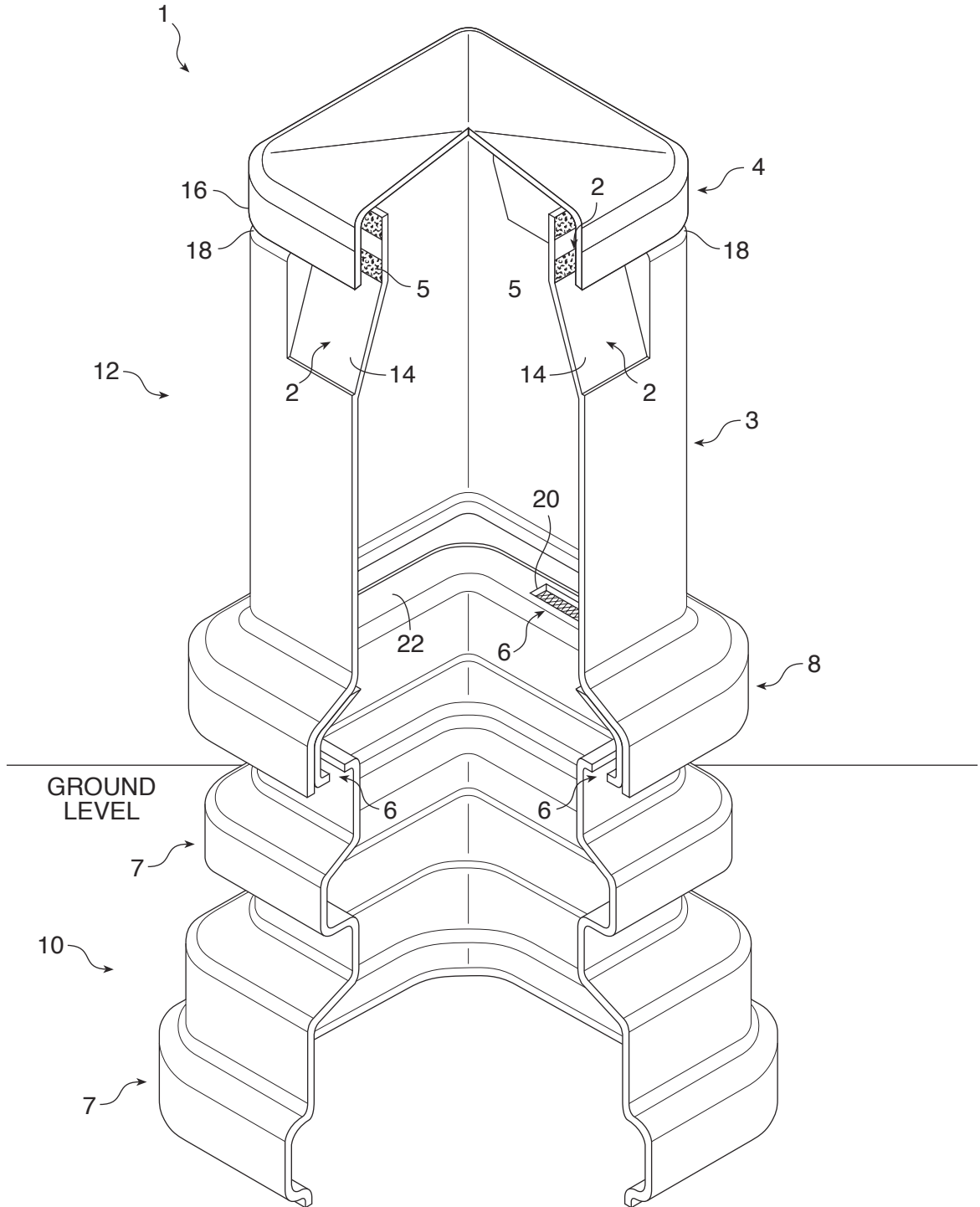

FIG. 2

+